







25-510 SLIMKEY

REV. 1.12

INSTALLATION

This module is designed to provide a default positive ignition output detected from the CANBUS of the vehicle. The output has a maximum output current of 1.5 A. The unit will self-recognize the CANBUS protocol in the car. The unique feature is that if necessary you can change the single output function to either : speedpulse output, lights, reverse parking sensors recovery (in some cars), mute for Blue & Me, reverse output under 10km / h. IF YOU NEED TWO OUTPUTS use 25-511 Slimkey2

Cable	
 RED	CONNECT TO A POSITIVE 12 V
 BLACK	CONNECT TO GND
 PINK	12 VDC IGNITION OUTPUT (DEFAULT)
 GREY	SPEED PULSE OUTPUT (OPTION)
 GREEN	CONNECT TO CAN HIGH
 WHITE	CONNECT TO CAN LOW



ATTENTION IT'S POSSIBLE TO MANAGE JUST ONE FUNCTION.

FUNCTION SELECTION PROCEDURE

If it's necessary to set the outputs in a different way respect the default setting it's needed to connect the unit in order to set the car canbus protocol then make the operation below described:

1. press and keep pressed the button of the unit till the LED green switch off, when the LED blinks RED once, please release the button.

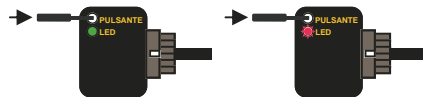

2. now released the button the LED of the module will blink Yellow followed by a Green blink and one pause. Now each time we press the button of the module the Green flashes of the LED will increase so verify the position number of the desired function listed in the TABLE attached.

3. once the desired function is set to confirm the selection press and keep pressed the button till the led lights switch OFF, then release the button ,the led will light GREEN.

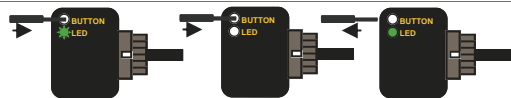

TABLE		
LED FLASHES	FUNCTION	WIRE
1 GREEN	IGNITION (DEFAULT)	PINK / ORANGE
2 GREEN	LIGHT POSITIVE OUTPUT	PINK / ORANGE
3 GREEN	BACK GEAR OUTPUT	PINK / ORANGE
4 GREEN	HAND BRAKE OUTPUT	PINK / ORANGE
5 GREEN	PARKING SENSOR BUZZER OUTPUT (SEE COMPATIBILITY LIST)	PINK / ORANGE
6 GREEN	MUTE OUTPUT FOR FIAT CARS WITH BLUE & ME	PINK / ORANGE
7 GREEN	SPEEDPULSE SIGNAL (26000 IMPULSES PER MILE)	GREY
8 GREEN	SPEEDPULSE SIGNAL (13000 IMPULSES PER MILE)	GREY
9 GREEN	SPEEDPULSE SIGNAL (8000 IMPULSES PER MILE)	GREY
1 RED	SPEEDPULSE SIGNAL (4000 IMPULSES PER MILE)	GREY
1 RED 1 GREEN	POSITIVE OUTPUT WHILE CAR DRIVING	PINK / ORANGE
1 RED 2 GREEN	POSITIVE OUTPUT WHILE CAR DRIVING BELOW 10 Km/h SPEED (FUNCTION ACTIVATED BY REVERSE GEAR)	PINK / ORANGE
1 RED 3 GREEN	POSITIVE OUTPUT TO SIGNAL EMERGENCY BRAKE WITH AUTOMATIC BLINKER ACTIVATION	PINK / ORANGE
1 RED 4 GREEN	POSITIVE OUTPUT BELOW 10 Km/h	PINK / ORANGE
1 RED 5 GREEN	POSITIVE OUTPUT WHILE CAR DRIVING BELOW 10 Km/h SPEED	PINK / ORANGE
1 RED 6 GREEN	POSITIVE OUTPUT WHILE CAR DRIVING BELOW 10 Km/h SPEED (FUNCTION ACTIVATED BY INSERTING BACKGEAR OR AT FIRST IGNITION)	PINK / ORANGE

TECHNICAL CHARACTERISTICS

POWER SUPPLY	10/16 VDC
SLEEP MODE COMSUMPTION	1 mA
WORKING MODE COMSUMPTION	1 A



WARNING!

THE MODULE SUPPLIES 12VDC OUTPUT, IF A NEG GROUND OUTPUT IS NEEDED PLEASE USE A RELAY



WARNING!

IF YOU NEED TO INSTAL THE SAME UNIT IN A NEW CAR (EVEN IF IN A SAME GROUP MODEL) IT IS NECESSARY TO RESET THE MODULE.

RESET:

1. WITH THE UNIT POWERED, PRESS AND KEEP PRESSED THE SLIMKEY BUTTON TILL THE LED SWITCH OFF.
2. WITH THE LED SWITCHED OFF RELEASE THE BUTTON, THE RESET IS DONE.

TROUBLESHOOTING

The unit doesn't carry out any function and the LED is off.

Verify the connections of the power supply.

The correctly powered unit doesn't carry out any function and the LED is off.

Verify the CANBUS connections.

The unit is connected correctly and the RED LED flashes quickly.

The unit hasn't been able to synchronize with the CANBUS, contact Paser.

The unit is connected correctly and the RED LED flashes in an irregular way.

Verify the CANBUS connections.

The unit is connected correctly and the RED LED is lit up.

The information in this guide and in its attaches are purely for information purposes, therefore, are subject to change without notice. At the time of publication the information is correct and reliable. However InCarTec can not be held responsible for any consequences resulting from errors, omissions or incongruence in this manual (for ex. according to missed audio configuration back-up of the vehicles).

CANBUS CONNECTIONS 25-510 SLIMKEY / 25-511 SLIMKEY 2
(SEEN FROM CABLE OUTPUT OF CONNECTORS) rev 1.13

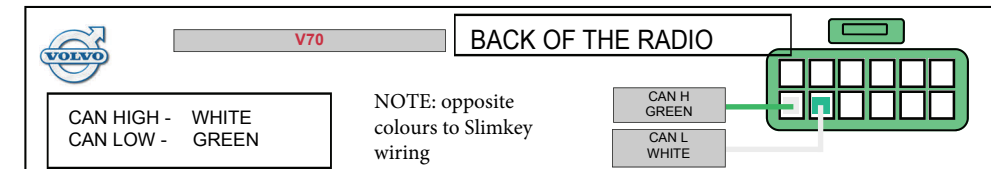
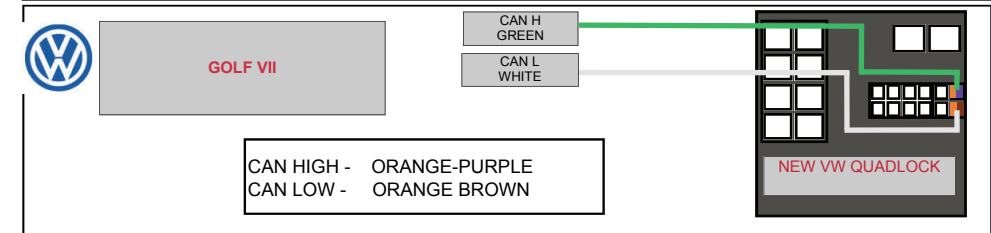
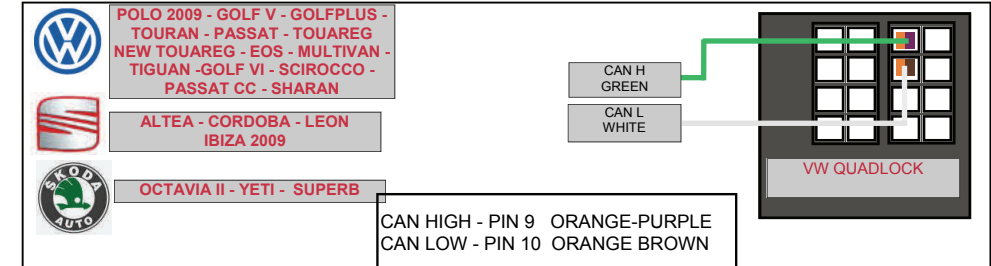
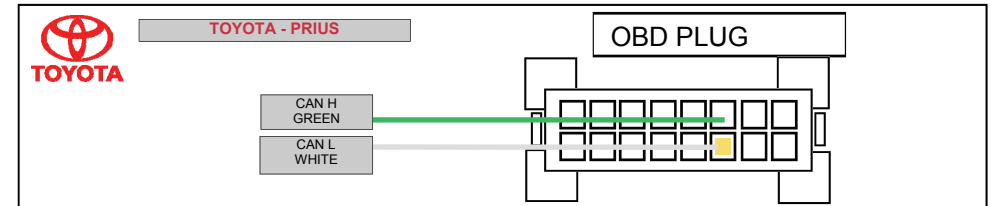
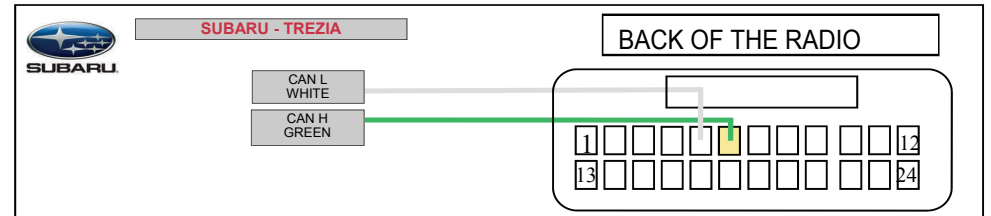
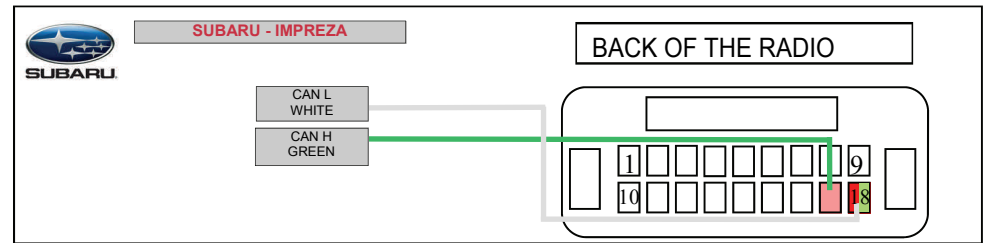
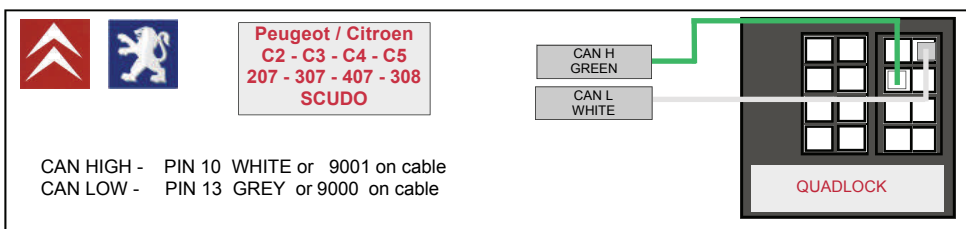
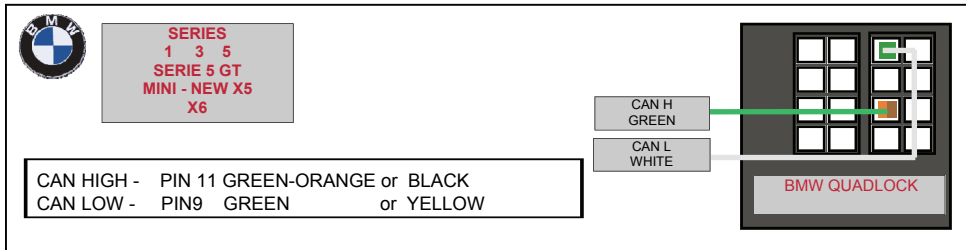
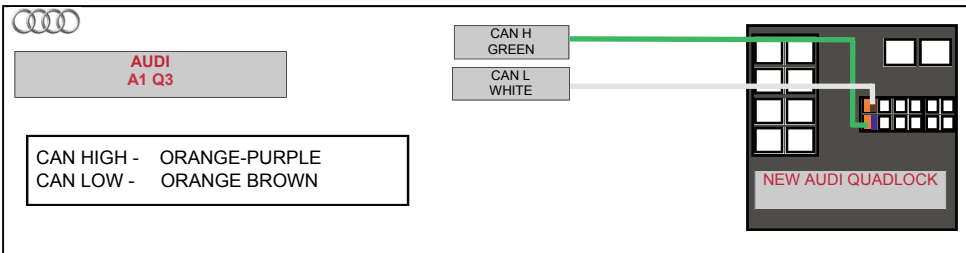
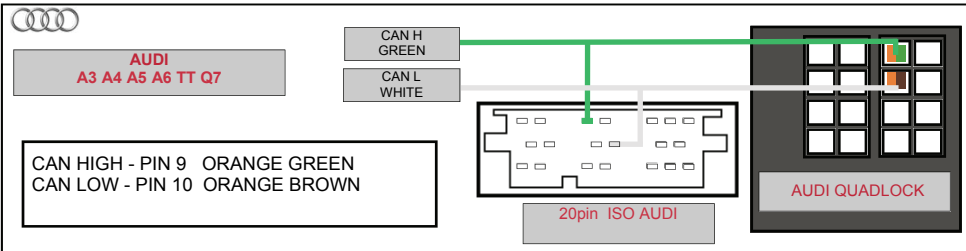
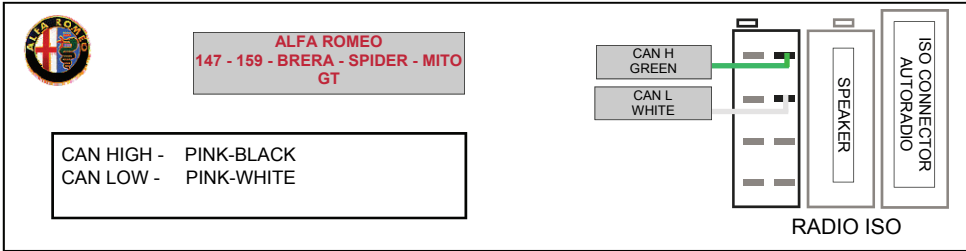

CANBUS CONNECTIONS 25-510 SLIMKEY / 25-511 SLIMKEY 2
(SEEN FROM CABLE OUTPUT OF CONNECTORS) rev 1.13

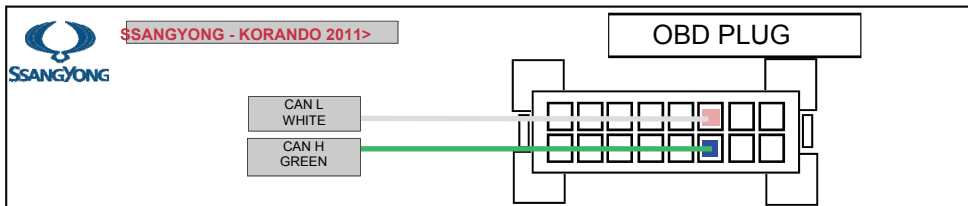
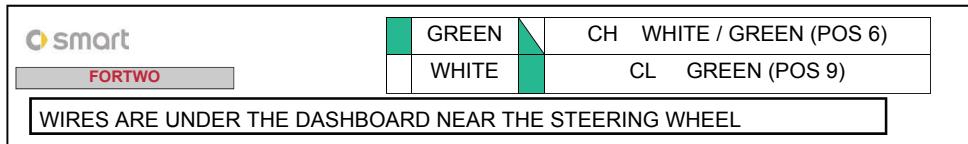
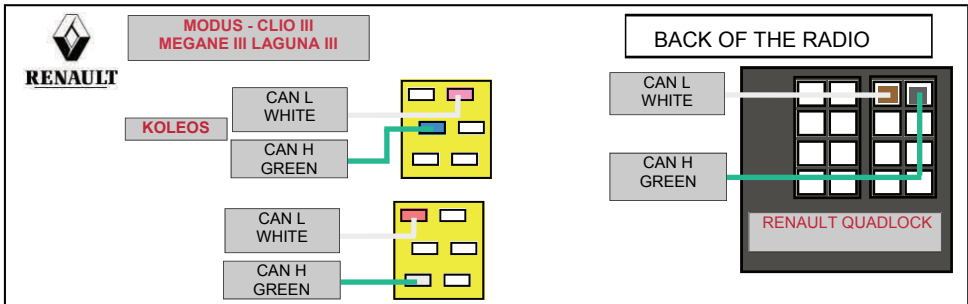
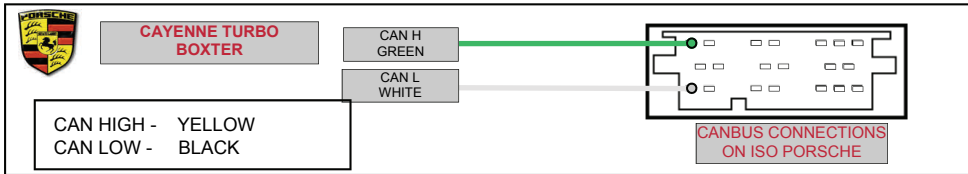
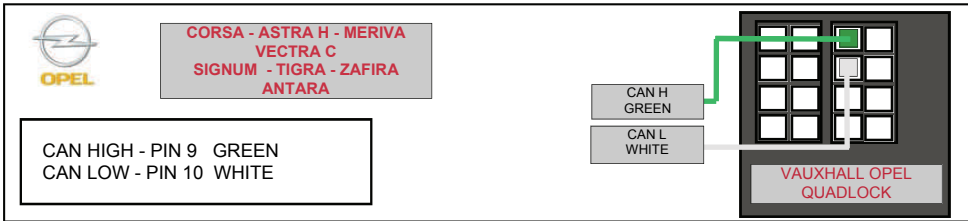

CANBUS CONNECTIONS 25-510 SLIMKEY / 25-511 SLIMKEY 2
(SEEN FROM CABLE OUTPUT OF CONNECTORS) rev 1.13

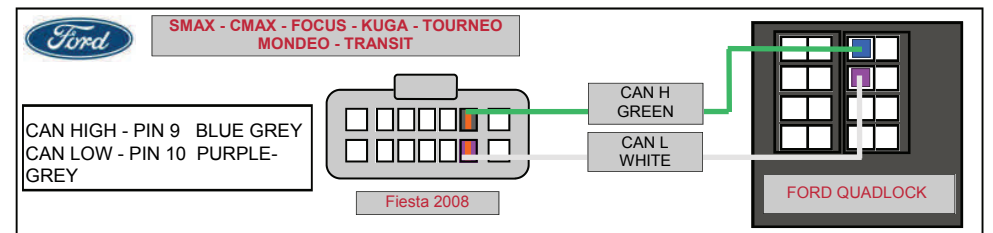
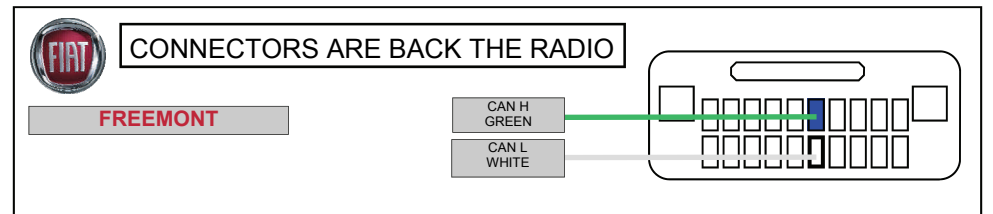
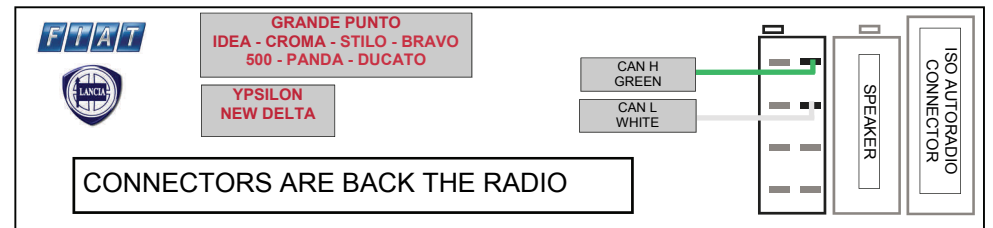
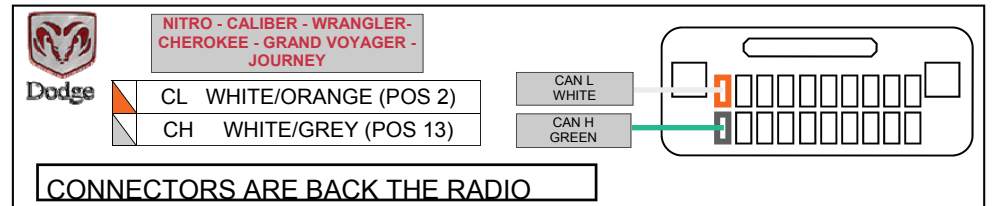
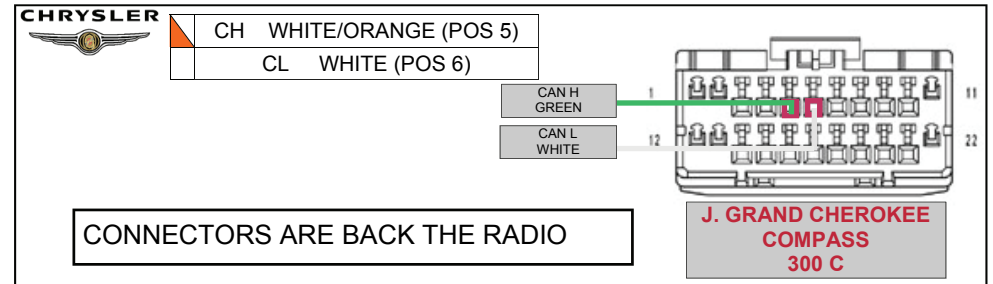

**CANBUS CONNECTIONS 25-510 SLIMKEY / 25-511 SLIMKEY 2
(SEEN FROM CABLE OUTPUT OF CONNECTORS) rev 1.13**

Ford **SMAX - CMAX - FOCUS 2011**

CONNECTORS ARE BACK THE RADIO

CAN H GREEN
CAN L WHITE

HYUNDAI **ix20**

THE CONNECTOR IS LOCATED DOWN THE DASHBOARD BEHIND A PLASTIC PANEL NEAR THE STEERING WHEEL

CAN H GREEN
CAN L WHITE

Jeep

GREEN	CH	WHITE/ORANGE (POS 13)
WHITE	CL	WHITE (POS 2)

WRANGLER

BACK OF THE RADIO

CAN H GREEN
CAN L WHITE

Jeep

GREEN	CH	WHITE/ORANGE (POS 2)
WHITE	CL	RED/WHITE (POS 13)

COMPASS 2012>

BACK OF THE RADIO

CAN H GREEN
CAN L WHITE

LAND-ROVER **RANGE ROVER - EVOQUE**

BACK OF THE RADIO

CAN H GREEN
CAN L WHITE

CAN HIGH - PINK- BROWN
CAN LOW - PURPLE-BROWN

LAND-ROVER **RANGE ROVER - FREELANDER II**

BACK OF THE RADIO

CAN H GREEN
CAN L WHITE

CAN HIGH - YELLOW- WHITE
CAN LOW - YELLOW-BLUE

**CANBUS CONNECTIONS 25-510 SLIMKEY / 25-511 SLIMKEY 2
(SEEN FROM CABLE OUTPUT OF CONNECTORS) rev 1.13**

LAND-ROVER **RANGE ROVER - FREELANDER II with Alpine upgrade**

CAN H GREEN
CAN L WHITE

CAN HIGH - ORANGE- GREY
CAN LOW - ORANGE-PURPLE

Mercedes-Benz **A - B - C - CLK - ML - R E - SPRINTER - GL - SL**

CAN H GREEN
CAN L WHITE

CAN HIGH - PIN 11 BROWN-RED
CAN LOW - PIN 9 BROWN

Mercedes-Benz **E - SLK Audio 20 NTG1**

CAN H GREEN
CAN L WHITE

CAN HIGH - BROWN-RED
CAN LOW - BROWN

Mercedes-Benz **A - SPRINTER VIANO - VITO**

CAN H GREEN
CAN L WHITE

CAN HIGH - BROWN-RED
CAN LOW - BROWN

ISO SOUND 5 Radio

NISSAN **QASHQAI - JUKE**

BACK OF THE RADIO

CAN L WHITE
CAN H GREEN